

Prosilica GC 650



- Sony ICX424 sensor
- 90 fps at full resolution
- Rugged housing
- Video-type auto iris

体积紧凑、性能强劲

Prosilica GC - 超紧凑千兆网相机

Prosilica GC 650 搭载 Sony ICX424 传感器，在 0.3 MP 分辨率下速度可达 90.0 帧/秒。

Prosilica GC 是一款千兆网相机，具有超紧凑、轻巧的外壳、快速的帧速率和自动光圈控制。它提供了高达 500 万像素的多种 CCD 和 CMOS 传感器选择，适用多种应用。

Easy software integration with [Allied Vision's Vimba Suite](#) and compatibility to the most popular third party image-processing libraries.

See the [Modular Concept](#) for lens mount, housing variants, optical filters, case design, and other modular options. See the [Customization and OEM Solutions webpage](#) for additional options.

性能参数

Prosilica GC 650	
接口	IEEE 802.3 1000baseT
分辨率	659 (H) × 493 (V)
传感器	Sony ICX424
传感器类型	CCD Progressive
快门种类	Global shutter
传感器尺寸	Type 1/3
像元尺寸	7.4 μm × 7.4 μm
标准镜头接口	C-Mount
最大满帧帧率	90 fps

Prosilica GC 650	
ADC	12 Bit
缓存 (RAM)	16 MByte
输出	
Bit 位数	8/12 Bit
黑白像素格式	Mono8, Mono12, Mono12Packed
RGB 彩色像素格式	RGB8Packed, BGR8Packed
原始像素格式	BayerRG8, BayerRG12, BayerGR12Packed
通用输入输出 (GPIOs)	
TTL I/Os	1 input, 1 output
光耦 I/Os	1 input, 1 output
RS232	1
工作条件/尺寸	
工作温度	0 °C to +50 °C ambient (without condensation)
电源要求 (DC)	5 to 25 VDC
功耗	3 W at 12 VDC
重量	99 g
尺寸 (L × W × H in mm)	59 × 46 × 33 (including connectors)
符合规范	CE: 2014/30/EU (EMC), 2011/65/EU, including amendment 2015/863/EU (RoHS); FCC Class A; CAN ICES-003

量子转换效率

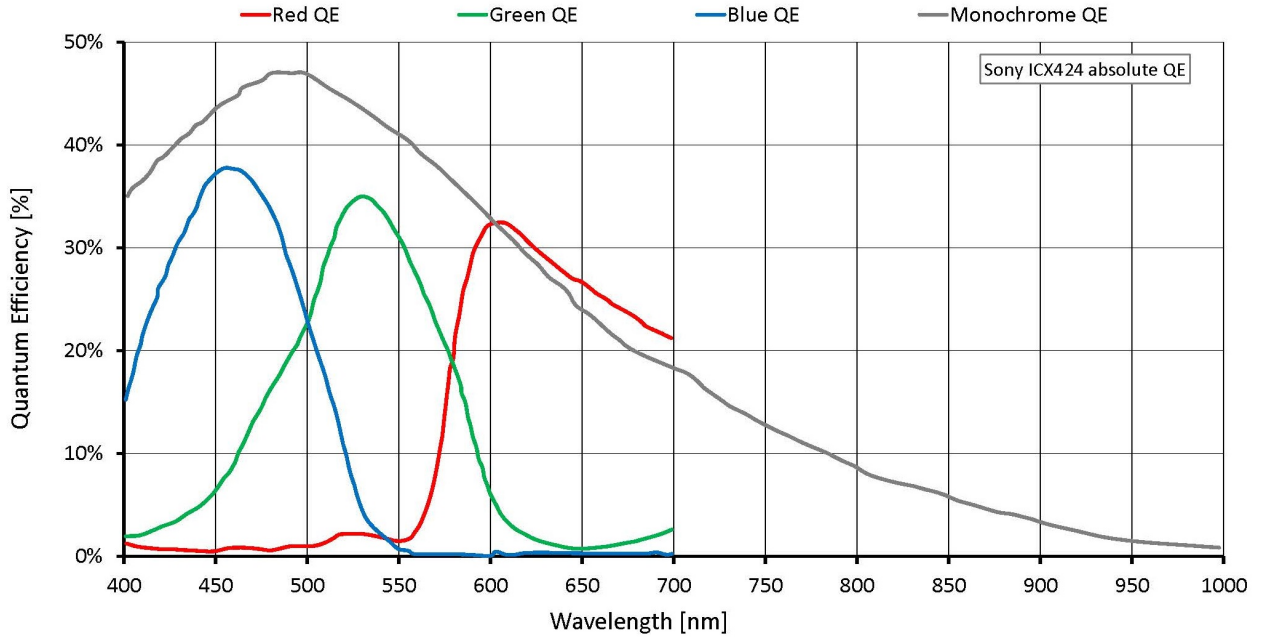

特性

Image optimization features:

- Auto gain (manual gain control: 0 to 19 dB)
- Auto exposure (manual exposure control: 8 μ s to 116.8 s at 1 μ s increments)
- Auto white balance
- Binning (horizontal and vertical) (sum)
- Region of interest, DSP subregion (selectable region for auto features)

Camera control features:

- Auto-iris (video type)
- Event channel
- Global shutter (digital shutter)
- IEEE 1588 Precision Time Protocol
- Image chunk data

- Recorder and Multiframe acquisition modes
- RS232
- Five storable user sets
- StreamBytesPerSecond (bandwidth control)
- Stream hold
- Sync out modes: Trigger ready, input, exposing, readout, imaging, strobe, GPO

外形尺寸

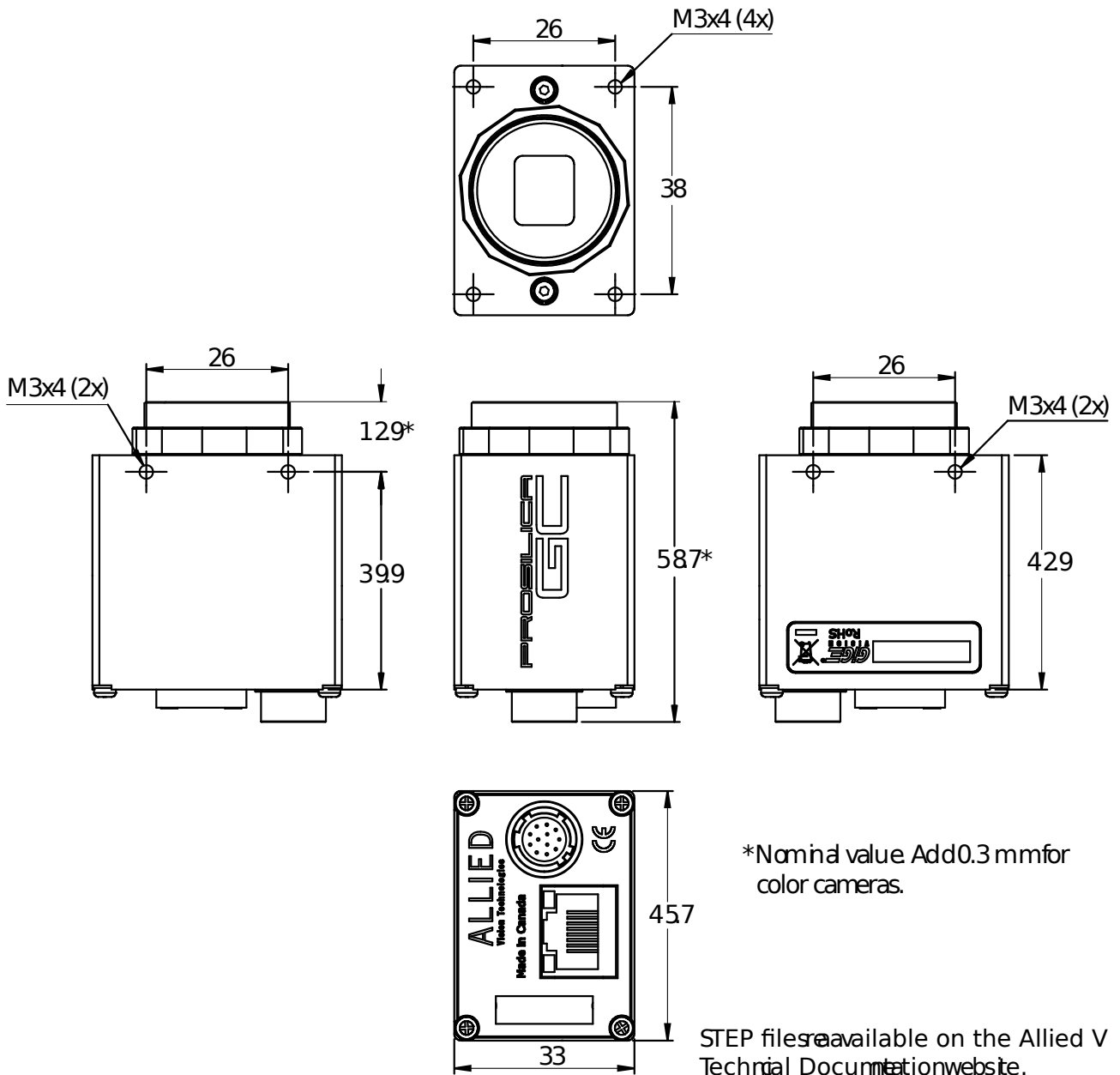

应用场景

Prosilica GC650 is ideal for a wide range of applications including:

- Machine vision
- Industrial inspection
- Public security
- Traffic monitoring
- Robotics