



Marlin F-033



- IEEE 1394a camera
- Modular design
- Robust housing
- Machine vision camera

Robust housing, modular design

Compact, flexible, modular IEEE 1394a XGA C-Mount camera

Marlin F-033 搭载 Sony ICX414 传感器，在 0.3 MP 分辨率下速度可达 73.0 帧/秒。

Acclaimed bestseller digital IEEE 1394 machine vision camera

The Marlin is Allied Vision's classical most-sold IEEE 1394 machine vision camera. Since 2004, many thousand Marlins are part of various different image processing applications. Due to its modular design (angled head, side-entry connectors, Modular Concept), it fits with almost every application.

- IEEE 1394a (400 Mb/s)
- Sony CCD sensors (1/3, 1/2, 1/1.8), 2/3 CMOS sensor
- 7 models (VGA to 2 Megapixel)
- Options
 - Various IR cut/pass filters
 - CS-Mount
 - Angled head
 - Lateral cable exit
 - White medical housing

性能参数

Marlin F-033

接口	IEEE 1394a - 400 Mb/s, 1 port
分辨率	656 (H) × 494 (V)

Marlin F-033

传感器	Sony ICX414
传感器类型	CCD Progressive
传感器尺寸	Type 1/2
像元尺寸	9.9 μm \times 9.9 μm
标准镜头接口	C-Mount
最大满帧帧率	73 fps
ADC	12 Bit
缓存 (RAM)	8 MByte
输出	
Bit 位数	8-10 Bit
黑白像素格式	Mono8, Mono16
RGB 彩色像素格式	RGB8
原始像素格式	Raw8
通用输入输出口 (GPIOs)	
光耦 I/Os	2 inputs, 2 outputs
RS232	1
工作条件/尺寸	
工作温度	+5 $^{\circ}\text{C}$ to +45 $^{\circ}\text{C}$
电源要求 (DC)	8 V to 36 V
功耗	<3 W (@ 12 VDC)
重量	<120 g
尺寸 (L \times W \times H in mm)	72 \times 44 \times 29 (including connectors)
符合规范	CE: 2014/30/EU (EMC), 2011/65/EU, including amendment 2015/863/EU (RoHS); FCC Class B

量子转换效率

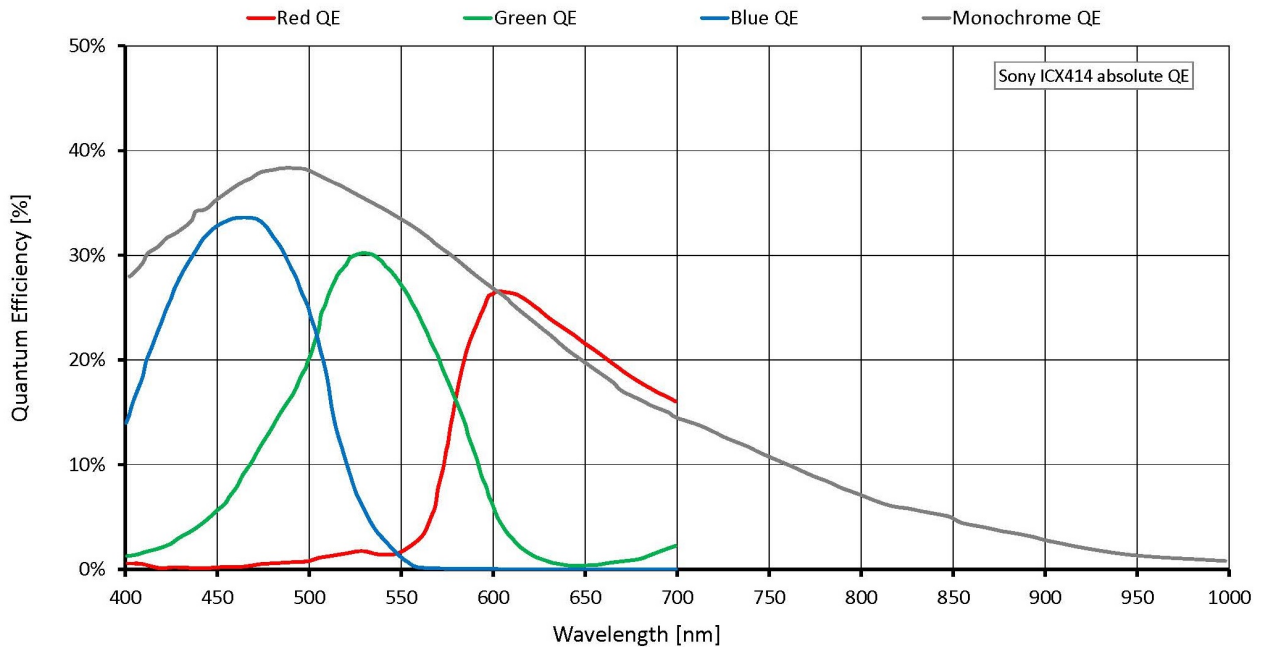

特性

Marlin cameras are equipped with many useful real-time image pre-processing functions. They are performed by the FPGA inside the camera – with no additional CPU load on the host, so that an inexpensive system is sufficient.

- Programmable look-up table (LUT), white balance, hue, saturation
- Debayering
- Gain
 - Auto/manual
 - Manual gain control: 0 to 24 dB
- Exposure
 - Auto/manual
 - Exposure time: 32 μ s to 67 s
- Color correction
- Shading correction
- Sub-sampling, 2x binning (b/w)

- Area of interest (AOI) with speed increase
- Sequence mode - changes the image settings on the fly
- Image mirror
- Deferred image transport
- SIS (secure image signature, time stamp for trigger, frame count)
- Storable user settings

外形尺寸

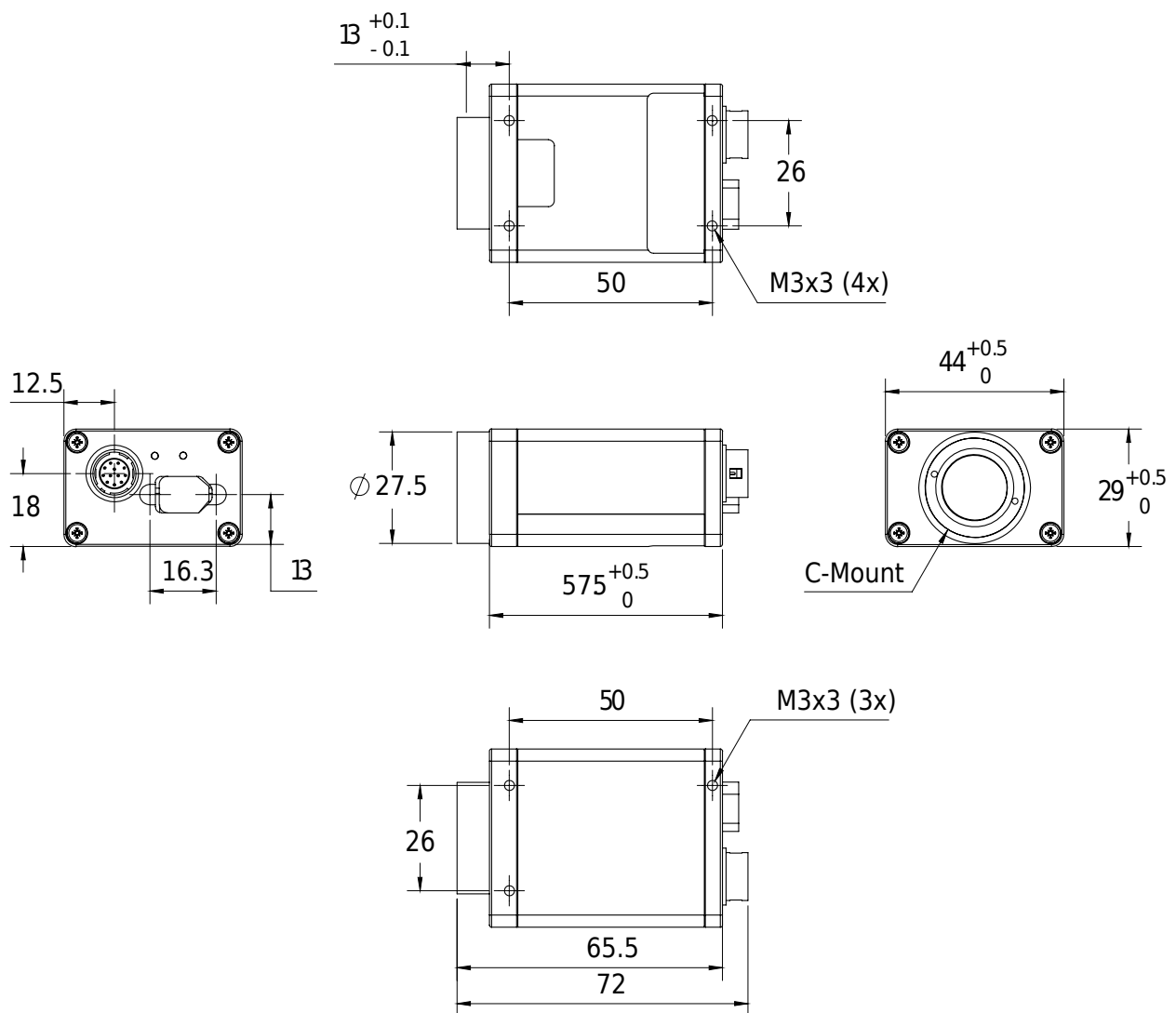

应用场景

With its modular and flexible design and the real-time pre-processing functions, this Marlin camera fits for many applications:

- Machine vision
- Quality control
- Semiconductor inspection
- Industrial inspection