

Prosilica GT 1910

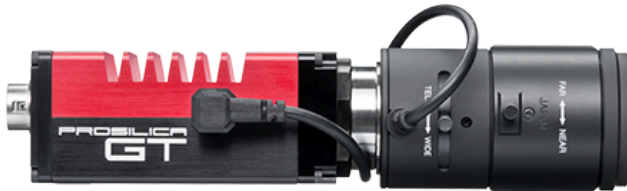

- Versatile temperature range for extreme environments
- PTP
- PoE
- P-Iris and DC-Iris lens control

2.1 Megapixel industrial camera for extended temperature ranges

Prosilica GT1910 is a 2.1 Megapixel camera with a GigE Vision compliant Gigabit Ethernet port and Hirose I/O port. Prosilica GT1910 is offered in both monochrome and color models. This camera incorporates the high quality ON Semiconductor KAI-02150 TRUESENSE CCD sensor providing excellent image quality in High Definition resolution (1080p). At full resolution, this camera runs 57.5 frames per second. With a smaller region of interest, higher frame rates are possible. It is a rugged camera designed to operate in extreme environments and fluctuating lighting conditions. This camera offers Precise iris lens control allowing users to fix the aperture size to optimize depth of field, exposure, and gain without the need for additional control elements. By default monochrome models ship with no optical filter and color models ship with an IRC30 IR cut filter.

Benefits and features:

- Monochrome (GT1910) and color (GT1910C) models
- GigE Vision interface with Power over Ethernet
- Screw mount RJ45 Ethernet connector for secure operation in industrial environments
- Supports cable lengths up to 100 meters (CAT-5e or CAT-6)
- Trigger over Ethernet (ToE) Action Commands allow for a single cable solution to reduce system costs
- Comprehensive I/O functionality for simplified system integration
- Popular C-Mount lens mount
- Easy camera mounting via standard M3 threads or optional tripod adapter



- Easy software integration with Allied Vision's [Vimba SDK](#) and compatibility to the most popular [third party image-processing libraries](#).

性能参数

Prosilica GT	1910
接口	IEEE 802.3 1000BASE-T, IEEE 802.3af (PoE)
分辨率	1920 (H) × 1080 (V)
传感器	ON Semi KAI-02150
传感器类型	CCD Progressive
Shutter mode	Global shutter
传感器尺寸	Type 2/3
像元尺寸	5.5 μm × 5.5 μm
Lens mounts (available)	C-Mount, CS-Mount, F-Mount, M42-Mount
最大满帧帧率	57.5 fps
ADC	14 Bit
缓存 (RAM)	128 MByte
非易失性内存 (Flash)	1024 KByte (for selected models only)

成像性能

成像性能数据是基于欧洲机器视觉协会 (EMVA) 1288发布的3.1版图像传感器和像机特征描述标准中的评估方法。测量值是在没有光学滤波片的全分辨率下，测量单色模型的典型值。请联系销售或工程师了解更多信息。

在波长为529nm下，量子转换效率	42 %
暗噪声	16.5 e ⁻
饱和电子数	19700 e ⁻
动态范围	61.3 dB
绝对灵敏度阈值	17.0 e ⁻

输出

Bit位数	14 (mono) - 12 (color) Bit
黑白像素格式	Mono8, Mono12, Mono12Packed, Mono14
YUV彩色像素格式	YUV411Packed, YUV422Packed, YUV444Packed
RGB彩色像素格式	RGB8Packed, BGR8Packed, RGBA8Packed, BGRA8Packed
原始像素格式	BayerGR8, BayerGR12, BayerRG12Packed

通用输入输出(GPIOs)

TTL I/Os	1 input, 2 outputs
光耦 I/Os	1 input, 2 outputs
RS232	1

工作条件/尺寸

Prosilica GT	1910
工作温度	-20 °C to +60 °C ambient (without condensation)
电源要求 (DC)	7 to 25 VDC AUX or 802.3at Type 1 PoE
功耗	5.1 W at 12VDC; 6.3 W PoE
重量	224 g
尺寸 (L × W × H in mm)	92 × 53.3 × 33 (including connectors)
符合规范	CE: 2014/30/EU (EMC), 2011/65/EU, including amendment 2015/863/EU (RoHS); FCC Class A; CAN ICES-3 (A)

量子转换效率

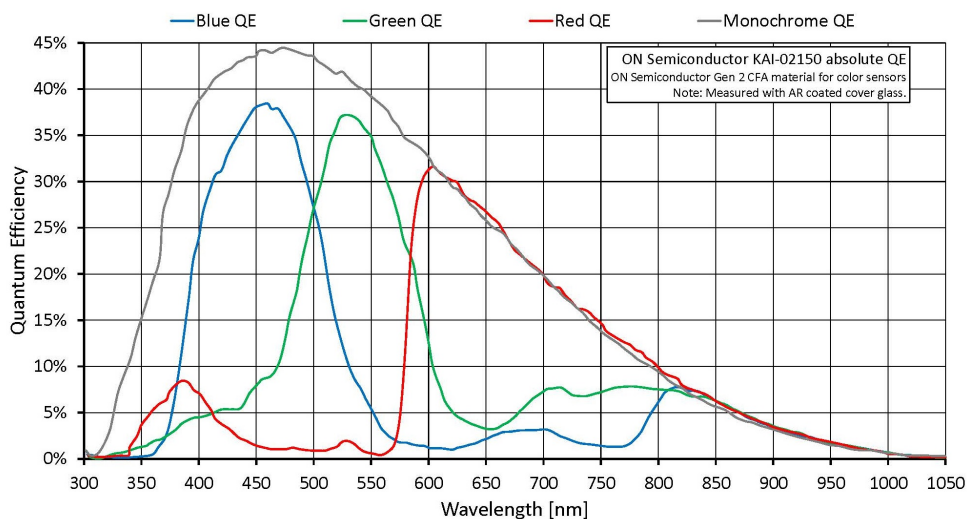

特性

Image optimization features:

- Auto gain (manual gain control: 0 to 32 dB)
- Auto exposure (manual exposure control: 10 μs to 26.8 s)
- Auto white balance (GT1910C only)
- Binning (horizontal and vertical)
- Color correction, hue, saturation (GT1910C only)
- Column defect masking
- Decimation X/Y
- Gamma correction



- Three look-up tables (LUTs)
- Region of interest (ROI), separate ROI for auto features
- Reverse X/Y

Camera control features:

- P-Iris and DC-Iris lens control
- Event channel
- Image chunk data
- IEEE 1588 Precision Time Protocol (PTP)
- RS232
- Storable user sets
- StreamBytesPerSecond (bandwidth control)
- Stream hold
- Sync out modes: Trigger ready, input, exposing, readout, imaging, strobe, GPO
- Tap mode switchable in Vimba Viewer 2.0 or later (four-tap, one-tap)
- Temperature monitoring (main board and sensor board)
- Trigger over Ethernet (ToE) Action Commands
- Non-volatile memory 1024 KByte (for selected models only)

外形尺寸

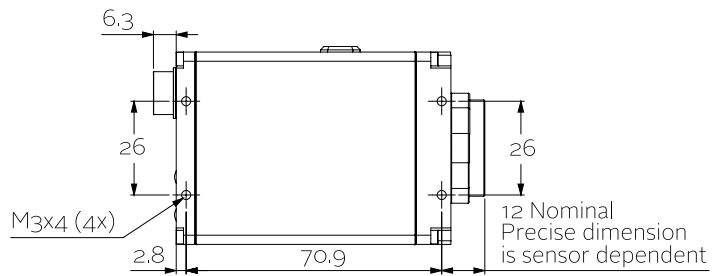
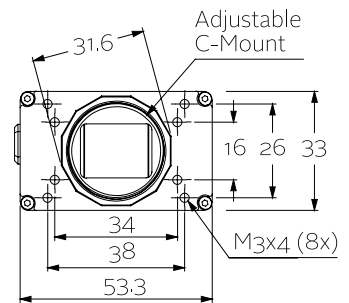
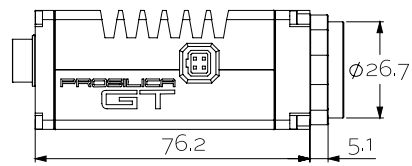
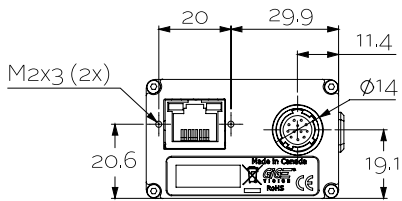
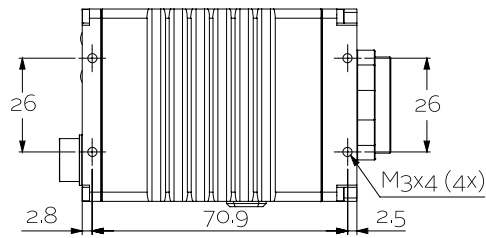



应用场景

Prosilica GT1910 is ideal for a wide range of applications including:

- Outdoor imaging
- Traffic imaging and ITS
- Public security and surveillance
- Industrial inspection
- Machine vision
- Military and space applications