



# Alvium 1800 U

## -040

- IMX287 CMOS sensor
- ALVIUM image processing
- USB3 Vision
- Various hardware options

## Versatile USB camera with IMX287 sensor

Alvium USB cameras are designed for use in both machine vision and embedded applications. Offering high image quality and reducing workload for the host, Alvium enables innovation among system designers. The innovative ALVIUM System on Chip (SoC) performs image corrections and preprocessing tasks onboard the camera instead of the host computer. Unlike FPGAs commonly used in machine vision cameras, the ALVIUM SoC is extremely power efficient. With Alvium, integrating hardware and software can be done effortlessly, which ultimately reduces development time. The Sony IMX287 CMOS sensor enables imaging at 0.4 megapixel and 281 frames per second. Color models ship with an IR cut filter, monochrome and S-Mount models ship without a filter or protection glass.

### Benefits and features

- Monochrome (1800 U-040m) and color (1800 U-040c) models
- ALVIUM® Technology for on-board image processing
- USB3 Vision interface for GenICam SFNC features
- Platform concept that enables the operation of different Alvium camera models with a common software
- Micro-B USB 3.1 Gen 1 connector with screw locks for industrial applications
- Precise sensor-to-lens mount alignment
- Standard M3 mounting holes for top and bottom mounting, standard M2 mounting holes for front mounting
- Industrial performance for both embedded and machine vision applications



## Hardware options

- Housings: Bare board, open housing, or closed housing
- Various lens mounts: C-Mount, CS-Mount, or S-Mount
- USB connector position: Select between the back panel or the left side of the camera (seen from the sensor side).

For more information on hardware options, including product codes and technical data, such as technical drawings and mass, see the [Alvium Cameras Hardware Options](#) document.

## Available accessories

- Tripod adapter
- USB 3.1 Gen 1 cable with screw connectors in various lengths
- I/O cables in various lengths
- Various lenses and Allied Vision S-Mount lenses with focal lengths 2.97 - 12 mm

## 性能参数

Alvium 1800 U	-040
接口	USB3 Vision
分辨率	728 (H) × 544 (V)
Spectral range	300 to 1100 nm
传感器	Sony IMX287
传感器类型	CMOS
Shutter mode	Global shutter
传感器尺寸	Type 1/2.9
像元尺寸	6.9 μm × 6.9 μm
Lens mounts (available)	C-Mount, CS-Mount, S-Mount
最大满帧帧率	281 fps at ≥200 MByte/s, Mono8
ADC	12 Bit
缓存 (RAM)	256 KB
非易失性内存 (Flash)	1024 KB

### 成像性能

Imaging performance data is based on the evaluation methods in the EMVA 1288 Release 3.1 standard for characterization of image sensors and cameras. Measurements are typical values for monochrome models measured without optical filter.

在波长为529nm下，量子转换效率	64 %
暗噪声	3.2 e <sup>-</sup>
饱和电子数	20800 e <sup>-</sup>

Alvium 1800 U	-040
动态范围	74 dB
绝对灵敏度阈值	4.0 e <sup>-</sup>
	输出
Bit位数	Max. 12 Bit
黑白像素格式	Mono8, Mono10, Mono12, Mono12p
YUV彩色像素格式	YCbCr411_8_CbYYCrYY, YCbCr422_8_CbYCrY, YCbCr8_CbYCr
RGB彩色像素格式	BayerGR8, BayerGR10, BayerGR10p, BayerRG12, BayerRG12p, BGR8, RGB8
	通用输入输出口(GPIOs)
TTL I/Os	4 programmable GPIOs
	工作条件/尺寸
工作温度	+5 °C to +65 °C housing temperature
电源要求 (DC)	Power over USB 3.1 Gen 1   External power 5.0 V
功耗	USB power: 1.9 W (typical)   Ext. power: 2.1 W (typical)
重量	15 g (bare board)
尺寸 (L × W × H in mm)	13 × 26 × 26 (bare board, standard), 13 × 30 × 26 (bare board, 90°)
符合规范	2011/65/EU, including amendment 2015/863/EU (RoHS)

## 量子转换效率

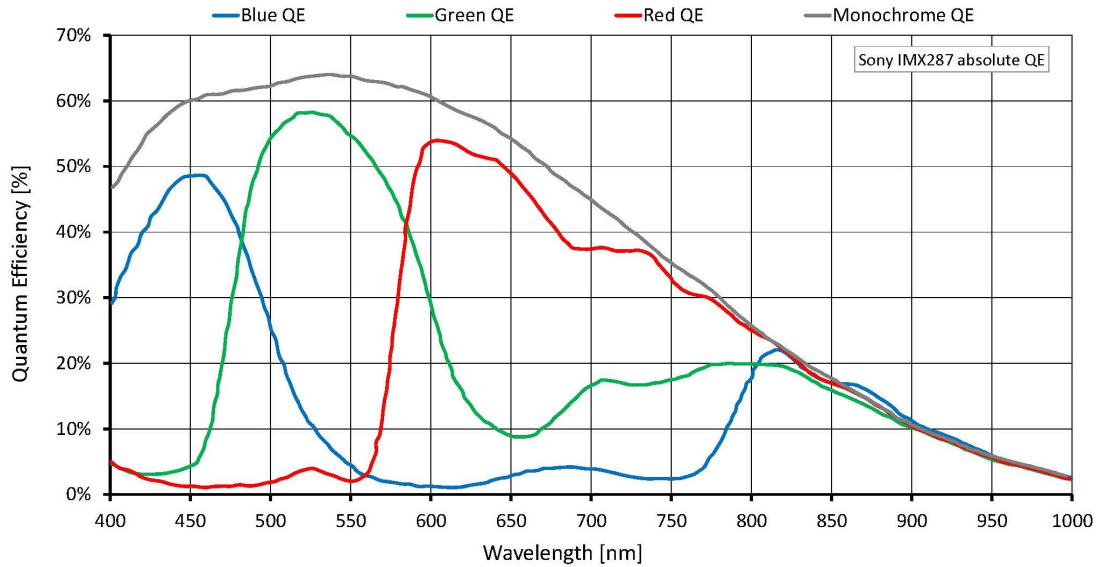

## 特性

### Image control

#### Auto control

- Auto exposure
- Auto gain
- Auto white balance (color models)
- Auto features regions control
- Auto features algorithms control

#### Other image controls

- Black level
- Contrast
- De-Bayering up to 5×5 (color models)
- DPC (factory calibrated)
- Exposure time
- Gain
- Gamma
- Hue (color models)



- Region of interest (ROI)
- Reverse X/Y
- Saturation (color models)

#### Camera control

- Sync out modes: Trigger ready, input
- Temperature monitoring (sensor board)
- Test image
- LED luminance control
- Firmware update

## 外形尺寸



Camera hardware options

The [Alvium Cameras Hardware Options](#) document informs about submodels, such as bare board or open housing cameras with different lens mounts.

### Bare Board

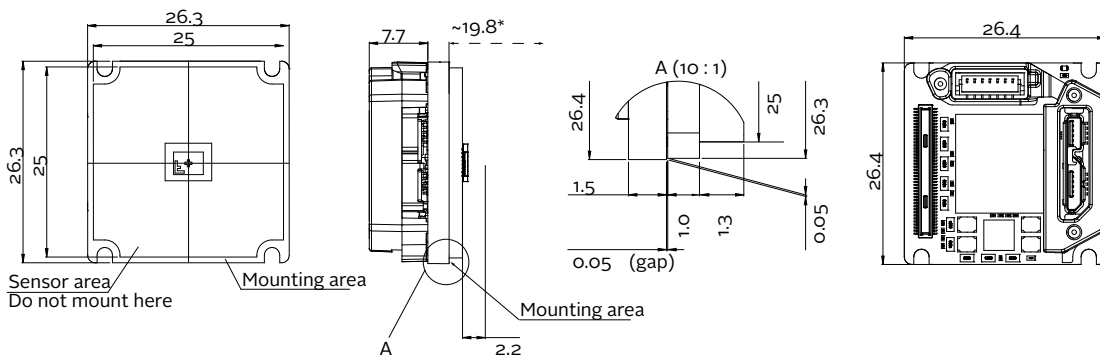

\*Mechanical length for C-Mount, for other mounts and details, see the user guide.

### Bare board 90°

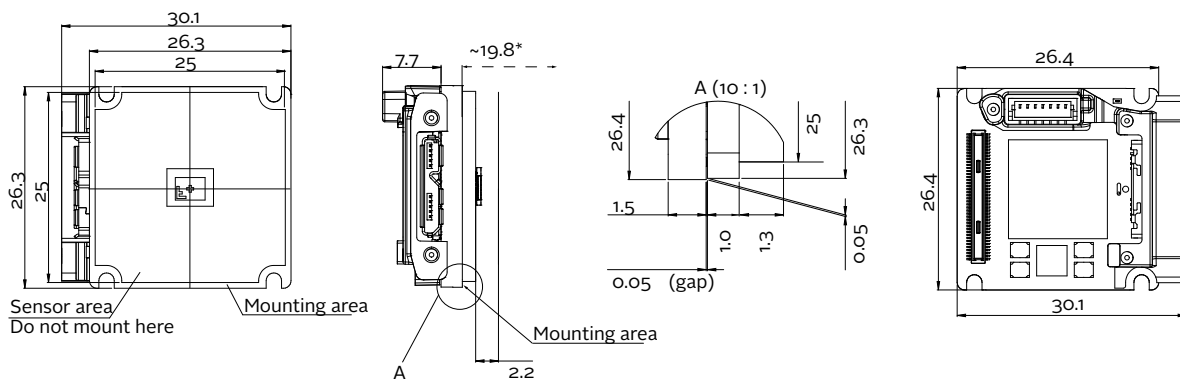

\*Mechanical length for C-Mount, for other mounts and details, see the user guide.